



2 HP Fixed Base Router

68341 Router

⚠ WARNING

**Read this material before using this product.
Failure to do so can result in serious injury.
SAVE THIS MANUAL.**



When unpacking, make sure that the product is intact and undamaged.
If any parts are missing or broken, please call 1-800-444-3353 as soon as possible.

Visit our website at: <http://www.harborfreight.com>

Specifications

Power	2 HP
Electrical Input	120 V~ / 60 Hz / 11 A (Rated)
Motor Speed	28,000 RPM (No Load)
Accepts Collet Sizes	1/4", 3/8", 1/2"
Maximum Cutting Depth	2-3/8"
Depth Measurements	1/64" increments
Accessories	1/4", 3/8" Collet Chucks Carbon Brushes Straight Trimmer Guide Two Wrenches



Save This Manual

Keep this manual for the safety warnings and precautions, assembly, operating, inspection, maintenance and cleaning procedures. Write the product's serial number in the back of the manual near the assembly diagram (or month and year of purchase if product has no number). Keep this manual and the receipt in a safe and dry place for future reference.

Important Safety Information

In this manual, on the labeling, and all other information provided with this product:



This is the safety alert symbol. It is used to alert you to potential personal injury hazards. Obey all safety messages that follow this symbol to avoid possible injury or death.

DANGER

DANGER indicates a hazardous situation which, if not avoided, will result in death or serious injury.

WARNING

WARNING indicates a hazardous situation which, if not avoided, could result in death or serious injury.

CAUTION

CAUTION, used with the safety alert symbol, indicates a hazardous situation which, if not avoided, could result in minor or moderate injury.

NOTICE

NOTICE is used to address practices not related to personal injury.

CAUTION

CAUTION, without the safety alert symbol, is used to address practices not related to personal injury.

General Power Tool Safety Warnings



WARNING Read all safety warnings and instructions. Failure to follow the warnings and instructions may result in electric shock, fire and/or serious injury.

Save all warnings and instructions for future reference.

The term "power tool" in the warnings refers to your mains-operated (corded) power tool.

- 1. Work area safety**
 - a. Keep work area clean and well lit.**
Cluttered or dark areas invite accidents.
 - b. Do not operate power tools in explosive atmospheres, such as in the presence of flammable liquids, gases or dust.** *Power tools create sparks which may ignite the dust or fumes.*
 - c. Keep children and bystanders away while operating a power tool.**
Distractions can cause you to lose control.
- 2. Electrical safety**
 - a. Power tool plugs must match the outlet. Never modify the plug in any way. Do not use any adapter plugs with grounded power tools.** *Unmodified plugs and matching outlets will reduce risk of electric shock.*
 - b. Avoid body contact with grounded surfaces such as pipes, radiators, ranges and refrigerators.** *There is an increased risk of electric shock if your body is grounded.*
 - c. Do not expose power tools to rain or wet conditions.** *Water entering a power tool will increase the risk of electric shock.*
 - d. Do not abuse the cord. Never use the cord for carrying, pulling or unplugging the power tool. Keep cord away from heat, oil, sharp edges or moving parts.** *Damaged or entangled cords increase the risk of electric shock.*
 - e. When operating a power tool outdoors, use an extension cord suitable for outdoor use.** *Use of a cord suitable for outdoor use reduces the risk of electric shock.*
 - f. If operating a power tool in a damp location is unavoidable, use a Ground Fault Circuit Interrupter (GFCI) protected supply.**
Use of a GFCI reduces the risk of electric shock.

3. Personal safety

- a. **Stay alert, watch what you are doing and use common sense when operating a power tool. Do not use a power tool while you are tired or under the influence of drugs, alcohol or medication.**
A moment of inattention while operating power tools may result in serious personal injury.
- b. **Use personal protective equipment. Always wear eye protection.** *Safety equipment such as dust mask, non-skid safety shoes, hard hat, or hearing protection used for appropriate conditions will reduce personal injuries.*
- c. **Prevent unintentional starting. Ensure the switch is in the off-position before connecting to power source and/or battery pack, picking up or carrying the tool.** *Carrying power tools with your finger on the switch or energizing power tools that have the switch on invites accidents.*
- d. **Remove any adjusting key or wrench before turning the power tool on.**
A wrench or a key left attached to a rotating part of the power tool may result in personal injury.
- e. **Do not overreach. Keep proper footing and balance at all times.** *This enables better control of the power tool in unexpected situations.*
- f. **Dress properly. Do not wear loose clothing or jewelry. Keep your hair, clothing and gloves away from moving parts.** *Loose clothes, jewelry or long hair can be caught in moving parts.*
- g. **If devices are provided for the connection of dust extraction and collection facilities, ensure these are connected and properly used.** *Use of these devices can reduce dust-related hazards.*
- h. **Only use safety equipment that has been approved by an appropriate standards agency.** *Unapproved safety equipment may not provide adequate protection. Eye protection must be ANSI-approved and breathing protection must be NIOSH-approved for the specific hazards in the work area.*

4. Power tool use and care

- a. **Do not force the power tool. Use the correct power tool for your application.** *The correct power tool will do the job better and safer at the rate for which it was designed.*
- b. **Do not use the power tool if the switch does not turn it on and off.**
Any power tool that cannot be controlled with the switch is dangerous and must be repaired.
- c. **Disconnect the plug from the power source and/or the battery pack from the power tool before making any adjustments, changing accessories, or storing power tools.**
Such preventive safety measures reduce the risk of starting the power tool accidentally.

- d. **Store idle power tools out of the reach of children and do not allow persons unfamiliar with the power tool or these instructions to operate the power tool.** *Power tools are dangerous in the hands of untrained users.*
- e. **Maintain power tools. Check for misalignment or binding of moving parts, breakage of parts and any other condition that may affect the power tool's operation. If damaged, have the power tool repaired before use.** *Many accidents are caused by poorly maintained power tools.*
- f. **Keep cutting tools sharp and clean.** *Properly maintained cutting tools with sharp cutting edges are less likely to bind and are easier to control.*
- g. **Use the power tool, accessories and tool bits etc. in accordance with these instructions, taking into account the working conditions and the work to be performed.** *Use of the power tool for operations different from those intended could result in a hazardous situation.*

5. Service

Have your power tool serviced by a qualified repair person using only identical replacement parts. *This will ensure that the safety of the power tool is maintained.*

Router Safety Warnings

1. **Hold power tool by insulated gripping surfaces when performing an operation where cutting tool may contact hidden wiring or its own cord.** *Contact with a "live" wire will make exposed metal parts of the tool "live" and shock the operator.*
2. **Use clamps or another practical way to secure and support the work piece to a stable platform.** *Holding the work by hand or against your body leaves it unstable and may lead to loss of control.*
3. Use only accessories rated at least equal to maximum speed marked on Router.
4. Only use router bits with a shank diameter equal to the size of the tool's collet. The collet size is adjustable for 1/4", 3/8" or 1/2".
5. Make sure the collet nut is securely tightened before use to prevent the router bit from slipping during use.
6. Do not use with base removed.
7. Hold router with both hands.
8. Keep hands away from the cutting area. Do not place hands beneath the workpiece for any reason. Keep the base of the router in firm contact with the workpiece while cutting.
9. Keep Handles dry, clean, and free of oil or grease. This will permit better control of the tool.
10. Do not use damaged bits.

11. Do not lay the Router down until it has stopped rotating completely.
12. Hold the Router firmly when starting, as startup rotation creates significant torque.
13. Hold the Router firmly while cutting. The action of the bit against the workpiece can cause it to “kick out”, jumping rapidly away from the workpiece. This can be caused by an improper type of bit, or a dull bit.
14. Do not handle the Router bit immediately after cutting. It may be very hot, potentially causing burns or injury.
15. Avoid overloading the tool. If the speed drops abnormally, decrease the pressure on the bit immediately. Do not apply excessive pressure to the router while cutting.
16. Always use sharpened bits. If the bit stops abruptly, or the bit becomes blocked, remove the Router from the workpiece and shut it off.
17. Do not start the Router while the bit is in contact with the workpiece. Allow the tool to reach its normal operating speed before applying the bit to the workpiece.
18. Use caution when setting the Locking Trigger Switch. Be aware that the router will continue to operate while the locking mechanism is engaged. Do not lay the router down or hand it to another person while the locking mechanism is engaged.
19. Before Routing, run the tool for about 10 seconds to ensure that all moving parts are running smoothly and there are no loose parts, rattles, or sparking that would indicate damage.
20. Maintain labels and nameplates on the tool. These carry important safety information. If unreadable or missing, contact Harbor Freight Tools for a replacement.
21. Avoid unintentional starting. Prepare to begin work before turning on the tool.
22. When using a handheld power tool, maintain a firm grip on the tool with both hands to resist starting torque.
23. Do not leave the tool unattended when it is plugged into an electrical outlet. Turn off the tool, and unplug it from its electrical outlet before leaving.
24. Only use accessories rated to the speed of the tool. Other accessories may fly apart, causing severe personal injury.
25. This product is not a toy. Keep it out of reach of children.
26. People with pacemakers should consult their physician(s) before use. Electromagnetic fields in close proximity to heart pacemaker could cause pacemaker interference or pacemaker failure. In addition, people with pacemakers should:
 - Avoid operating alone.
 - Do not use with power switch locked on.
 - Properly maintain and inspect to avoid electrical shock.
 - Any power cord must be properly grounded. Ground Fault Circuit Interrupter (GFCI) should also be implemented – it prevents sustained electrical shock.
27. **WARNING:** Some dust created by power sanding, sawing, grinding, drilling, and other construction activities, contains chemicals known [to the State of California] to cause cancer, birth defects or other reproductive harm. Some examples of these chemicals are:
 - Lead from lead-based paints
 - Crystalline silica from bricks and cement or other masonry products
 - Arsenic and chromium from chemically treated lumber
 Your risk from these exposures varies, depending on how often you do this type of work. To reduce your exposure to these chemicals: work in a well ventilated area, and work with approved safety equipment, such as those dust masks that are specially designed to filter out microscopic particles.
(California Health & Safety Code § 25249.5, *et seq.*)
28. **WARNING:** Handling the cord on this product will expose you to lead, a chemical known to the State of California to cause cancer, and birth defects or other reproductive harm. Wash hands after handling.
(California Health & Safety Code § 25249.5, *et seq.*)
29. The warnings, precautions, and instructions discussed in this instruction manual cannot cover all possible conditions and situations that may occur. It must be understood by the operator that common sense and caution are factors which cannot be built into this product, but must be supplied by the operator.

Vibration Safety

This tool vibrates during use.

Repeated or long-term exposure to vibration may cause temporary or permanent physical injury, particularly to the hands, arms and shoulders. To reduce the risk of vibration-related injury:

1. Anyone using vibrating tools regularly or for an extended period should first be examined by a doctor and then have regular medical check-ups to ensure medical problems are not being caused or worsened from use. Pregnant women or people who have impaired blood circulation to the hand, past hand injuries, nervous system disorders, diabetes, or Raynaud’s Disease should not use this tool. If you feel any symptoms related to vibration (such as tingling, numbness, and white or blue fingers), seek medical advice as soon as possible.

2. Do not smoke during use. Nicotine reduces the blood supply to the hands and fingers, increasing the risk of vibration-related injury.
3. Wear suitable gloves to reduce the vibration effects on the user.
4. Use tools with the lowest vibration when there is a choice.
5. Include vibration-free periods each day of work.
6. Grip tool as lightly as possible (while still keeping safe control of it). Let the tool do the work.
7. To reduce vibration, maintain the tool as explained in this manual. If any abnormal vibration occurs, stop use immediately.



SAVE THESE INSTRUCTIONS.

Grounding

⚠ WARNING



TO PREVENT ELECTRIC SHOCK AND DEATH FROM INCORRECT GROUNDING WIRE CONNECTION:

Check with a qualified electrician if you are in doubt as to whether the outlet is properly grounded. Do not modify the power cord plug provided with the tool. Never remove the grounding prong from the plug. Do not use the tool if the power cord or plug is damaged. If damaged, have it repaired by a service facility before use. If the plug will not fit the outlet, have a proper outlet installed by a qualified electrician.

Grounded Tools: Tools with Three Prong Plugs

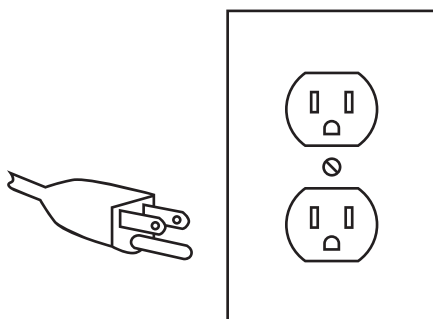

3-Prong Plug and Outlet

1. Tools marked with "Grounding Required" have a three wire cord and three prong grounding plug. The plug must be connected to a properly grounded outlet. If the tool should electrically malfunction or break

down, grounding provides a low resistance path to carry electricity away from the user, reducing the risk of electric shock. (See 3-Prong Plug and Outlet.)

2. The grounding prong in the plug is connected through the green wire inside the cord to the grounding system in the tool. The green wire in the cord must be the only wire connected to the tool's grounding system and must never be attached to an electrically "live" terminal. (See 3-Prong Plug and Outlet.)
3. The tool must be plugged into an appropriate outlet, properly installed and grounded in accordance with all codes and ordinances. The plug and outlet should look like those in the preceding illustration. (See 3-Prong Plug and Outlet.)

Double Insulated Tools: Tools with Two Prong Plugs

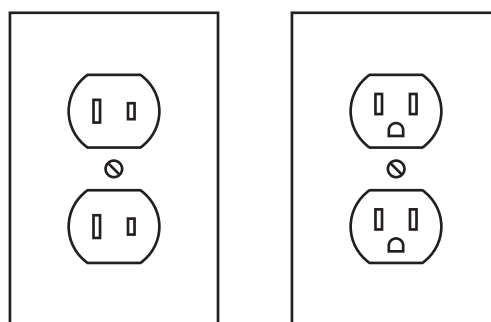

Outlets for 2-Prong Plug

1. Tools marked "Double Insulated" do not require grounding. They have a special double insulation system which satisfies OSHA requirements and complies with the applicable standards of Underwriters Laboratories, Inc., the Canadian Standard Association, and the National Electrical Code.
2. Double insulated tools may be used in either of the 120 volt outlets shown in the preceding illustration. (See Outlets for 2-Prong Plug.)

Extension Cords











1. **Grounded** tools require a three wire extension cord. **Double Insulated** tools can use either a two or three wire extension cord.
2. As the distance from the supply outlet increases, you must use a heavier gauge extension cord. Using extension cords with inadequately sized wire causes a serious drop in voltage, resulting in loss of power and possible tool damage. (See Table A on page 6.)
3. The smaller the gauge number of the wire, the greater the capacity of the cord. For example, a 14 gauge cord can carry a higher current than a 16 gauge cord. (See Table A.)

4. When using more than one extension cord to make up the total length, make sure each cord contains at least the minimum wire size required. **(See Table A.)**
5. If you are using one extension cord for more than one tool, add the nameplate amperes and use the sum to determine the required minimum cord size. **(See Table A.)**
6. If you are using an extension cord outdoors, make sure it is marked with the suffix "W-A" ("W" in Canada) to indicate it is acceptable for outdoor use.
7. Make sure the extension cord is properly wired and in good electrical condition. Always replace a damaged extension cord or have it repaired by a qualified electrician before using it.
8. Protect the extension cords from sharp objects, excessive heat, and damp or wet areas.

TABLE A: RECOMMENDED MINIMUM WIRE GAUGE FOR EXTENSION CORDS* (120/240 VOLT)					
NAMEPLATE AMPERES (at full load)	EXTENSION CORD LENGTH				
	25'	50'	75'	100'	150'
0 – 2.0	18	18	18	18	16
2.1 – 3.4	18	18	18	16	14
3.5 – 5.0	18	18	16	14	12
5.1 – 7.0	18	16	14	12	12
7.1 – 12.0	18	14	12	10	-
12.1 – 16.0	14	12	10	-	-
16.1 – 20.0	12	10	-	-	-

*** Based on limiting the line voltage drop to five volts at 150% of the rated amperes.**

Symbology

	Double Insulated
	Canadian Standards Association
	Underwriters Laboratories, Inc.
	Volts Alternating Current
	Amperes
n_0 xxxx/min.	No Load Revolutions per Minute (RPM)
	WARNING marking concerning Risk of Eye Injury. Wear ANSI-approved safety goggles with side shields.
	Read the manual before set-up and/or use.
	WARNING marking concerning Risk of Hearing Loss. Wear hearing protection.
	WARNING marking concerning Risk of Fire. Do not cover ventilation ducts. Keep flammable objects away.
	WARNING marking concerning Risk of Electric Shock. Properly connect power cord to appropriate outlet.

Instructions for Putting into Use



Read the **ENTIRE IMPORTANT SAFETY INFORMATION** section at the beginning of this manual including all text under subheadings therein before set up or use of this product.

WARNING

TO PREVENT SERIOUS INJURY FROM ACCIDENTAL OPERATION:

Turn the Power Switch off and unplug the Router before adjusting or installing accessories.

Note: For additional information regarding the parts listed in the following pages, refer to *Parts List* on page 12.

Components



Figure 1

Operating Instructions



Read the **ENTIRE IMPORTANT SAFETY INFORMATION** section at the beginning of this manual including all text under subheadings therein before set up or use of this product.

WARNING

TO PREVENT SERIOUS INJURY FROM ACCIDENTAL OPERATION:
Turn the Power Switch off and unplug the Router before adjusting or installing accessories.

Tool Set Up

Installing Bits

- 1 Unlock the Lock Lever (30).



- 2 Rotate the Main Housing to raise or lower the Spindle so you can access the Spindle and Collet Nut with the Wrenches.

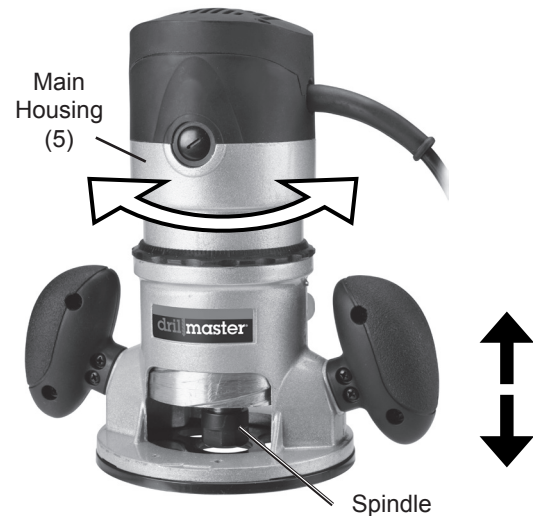

- 3 Turn the Router upside down and hold the Spindle in place with the Spindle Wrench while turning the Collet Nut counterclockwise with the Collet Nut Wrench to loosen the Collet Nut.

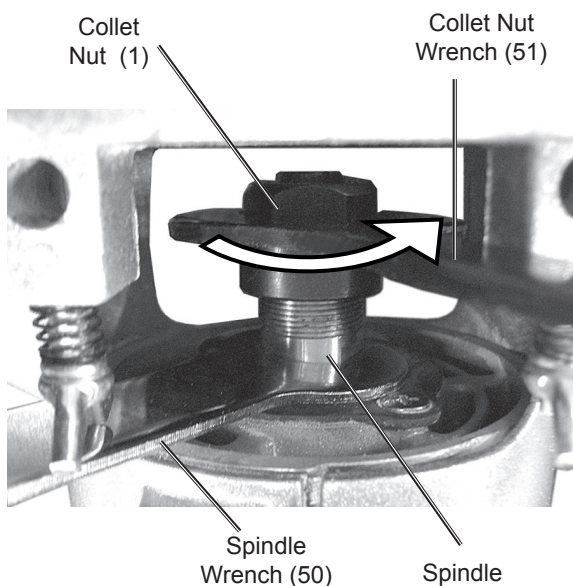

- 4 Remove or insert a Collet Chuck as needed to fit the bit size, then insert the bit (sold separately) and tighten the Collet Nut with the Wrenches.

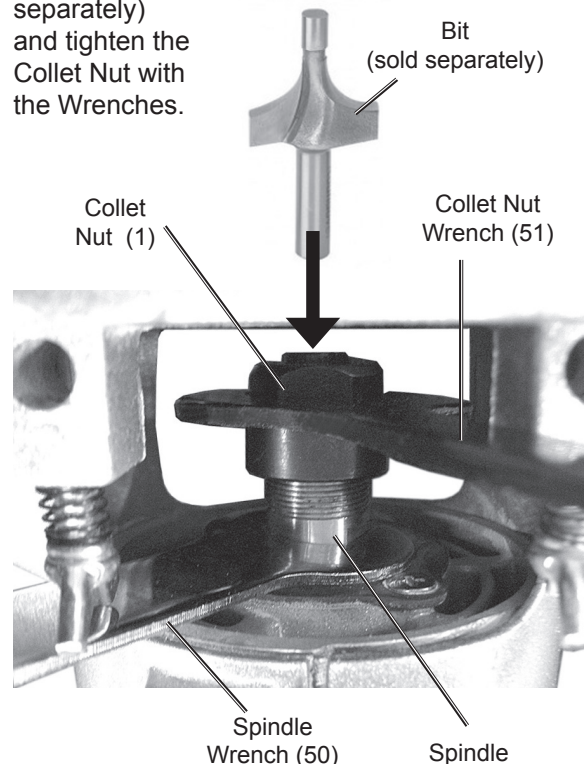

Adjusting the Cutting Depth

- 1 Place the router on a flat wood surface. Unlock the Lock Lever (30).

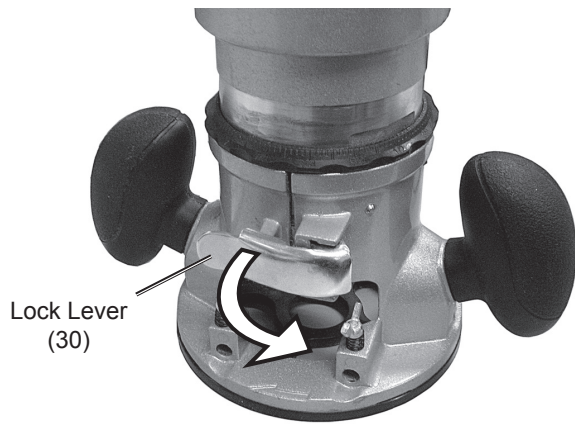

- 2 Rotate the Main Housing until the tip of the bit touches the workpiece surface. Lock the Lock Lever.

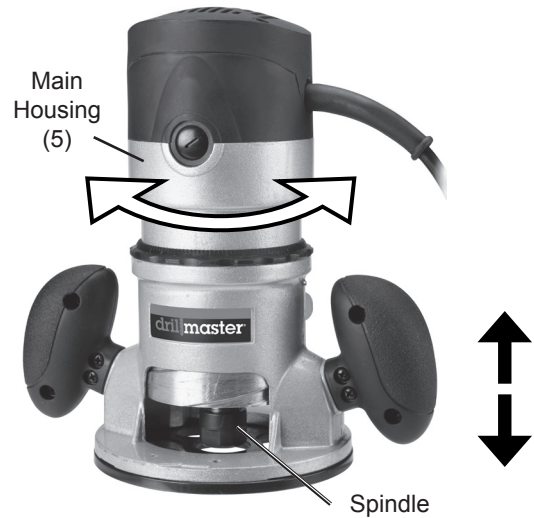

- 3 Slide the Scale Ring until the "0" aligns with the index line (vertical mark) on the Main Housing. Unlock the Lock Lever. Each line on the scale raises or lowers the bit by 1/64".

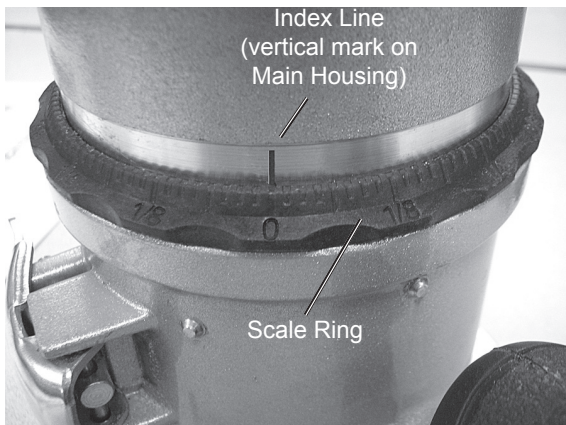

- 4 While holding the Base up from the surface, rotate the Main Housing to raise or lower the bit until the index line on the housing aligns with the desired depth on the scale ring. Lock the Lock Lever.

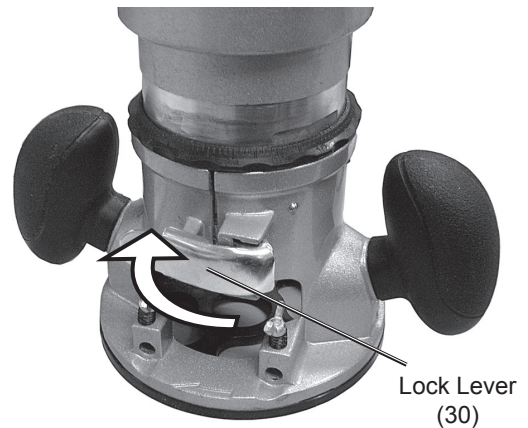

Attaching Guide

To attach the Guide (24) when making straight cuts:

1. Loosen the four Wing Nuts (27 and 37).
2. Slide the Guide Poles (28) on the Guide (24) into the slots on the Base of the Router with the Guide facing the workpiece.
3. Adjust the distance between the router bit and the Guide to the desired setting.
4. Tighten the Wing Nuts (27 and 37).

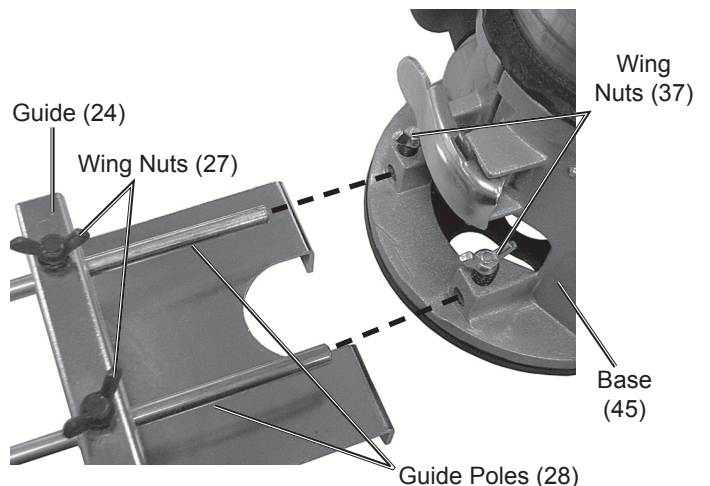

Work Piece and Work Area Set Up

1. Designate a work area that is clean and well-lit. The work area must not allow access by children or pets to prevent distraction and injury.
2. Route the power cord along a safe route to reach the work area without creating a tripping hazard or exposing the power cord to possible damage. The power cord must reach the work area with enough extra length to allow free movement while working.
3. Secure loose work pieces using a vise or clamps (not included) to prevent movement while working.
4. Make sure there are no metal objects in the wood which might make contact with the router bit.

General Operating Instructions

Note: Use two or more passes for deep cuts, especially in the case of hardwood. Do not attempt to cut deeper than 5/8" in a single pass. Adjust the cutting depth so that the first pass will be less than 5/8" deep, then follow the procedures for Adjusting the Cutting Depth for each progressive pass, until the final depth is achieved.

Note: Feed the Router bit into the workpiece **against** the bit's direction of rotation.

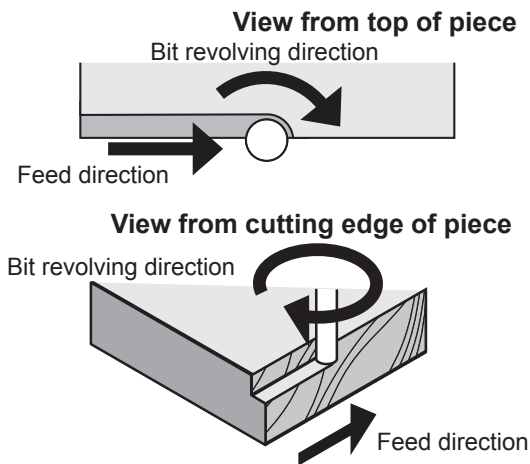

When cutting outside edges, guide the router counterclockwise around the workpiece. Move it clockwise when cutting inside edges.

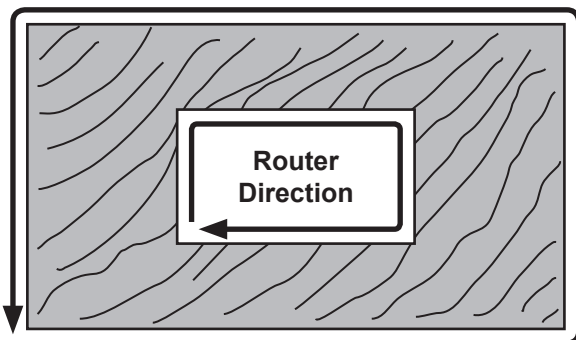

WARNING! Moving the router against the recommended direction can cause serious injury from kickback.

Note: Make practice cuts at different speeds in scrap material until you are able to produce a smooth cut with no burnishing or burn marks. Burn marks are caused by moving too slowly through the wood. Feeding the Router too quickly, or trying to remove too much material in a single pass creates a rough cut and can overload the motor.

WARNING! When first turning on the Router, grip the Handles firmly as the tool may try to twist from the strong initial torque.

1. Hold the Router handles firmly with both hands.
2. Place the Router directly above the point you plan to cut. Verify that there are no obstructions in the cutting path.
3. Turn on the Router.
4. Before cutting material, watch and feel for vibration which could indicate an improperly installed bit. Turn off and re-install bit, if needed.
5. Allow the bit to come to full speed, slowly engage material. **DO NOT** force the Router down into the material.



6. When finished, raise the Router so the bit is clear of the material, then turn the Power Switch off. Do not set the Router down until the bit has come to a complete stop.
7. Do not touch the bit right after cutting. It becomes very hot. Allow to cool before changing bits.
8. Do not leave the router running when not actually cutting. Turn power off between cuts.
9. To prevent accidents, disconnect the power supply after use. Clean, then store the tool indoors out of children's reach.

Maintenance and Servicing



Procedures not specifically explained in this manual must be performed only by a qualified technician.

WARNING

TO PREVENT SERIOUS INJURY FROM ACCIDENTAL OPERATION:

Turn the Power Switch off and unplug the Router before performing any inspection, maintenance, or cleaning procedures.

TO PREVENT SERIOUS INJURY FROM TOOL FAILURE:

Do not use damaged equipment. If abnormal noise or vibration occurs, have the problem corrected before further use.

Cleaning, Maintenance, and Lubrication

- BEFORE EACH USE**, inspect the general condition of the tool. Check for loose hardware, misalignment or binding of moving parts, cracked or broken parts, damaged electrical wiring, and any other condition that may affect its safe operation.
- AFTER USE**, wipe external surfaces of the tool with clean cloth.
- Regularly clean all ventilation openings by periodically brushing with a soft brush and/or blowing clear with compressed air.

- WARNING!** If the supply cord of this power tool is damaged, it must be replaced only by a qualified service technician.

Replacing Carbon Brushes

Remove and check the Carbon Brushes regularly. Replace when they wear down to the limit mark on the carbon. Replace both brushes at the same time. To replace: Remove the Brush Caps and old brushes, then insert the new brushes and secure the caps in place.

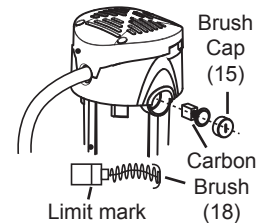

Troubleshooting

Problem	Possible Causes	Likely Solutions
Tool will not start.	<ol style="list-style-type: none"> Cord not connected. No power at outlet. Tool's thermal reset breaker tripped (if equipped). Internal damage or wear. (Carbon brushes or switch, for example.) 	<ol style="list-style-type: none"> Check that cord is plugged in. Check power at outlet. If outlet is unpowered, turn off tool and check circuit breaker. If breaker is tripped, make sure circuit is right capacity for tool and circuit has no other loads. Turn off tool and allow to cool. Press reset button on tool. Have technician service tool.
Tool operates slowly.	Extension cord too long or wire size too small.	Eliminate use of extension cord. If an extension cord is needed, use shorter/heavier gauge cord. See <i>Extension Cords</i> in <i>Grounding</i> section on page 5.
Performance decreases over time.	<ol style="list-style-type: none"> Accessory dull or damaged. Carbon brushes worn or damaged. 	<ol style="list-style-type: none"> Keep cutting accessories sharp. Replace as needed. Have qualified technician replace brushes.
Excessive noise or rattling.	Internal damage or wear. (Carbon brushes or bearings, for example.)	Have technician service tool.
Overheating.	<ol style="list-style-type: none"> Forcing tool to work too fast. Accessory misaligned. Accessory dull or damaged. Blocked motor housing vents. Motor being strained by long or small diameter extension cord. 	<ol style="list-style-type: none"> Allow tool to work at its own rate. Check and correct accessory to fence and/or table alignment. Keep cutting accessories sharp. Replace as needed. Wear ANSI-approved safety goggles and NIOSH-approved dust mask/respirator while blowing dust out of motor using compressed air. Eliminate use of extension cord. If an extension cord is needed, use one with the proper diameter for its length and load. See <i>Extension Cords</i> in <i>Grounding</i> section on page 5.



Follow all safety precautions whenever diagnosing or servicing the tool. Disconnect power supply before service.

Parts List

Part	Description	Qty
1	Collet Nut	1
2	Bolt	2
3	Bearing Support	1
4	Bearing	1
5	Main Housing	1
6	Screw	2
7	Cover	1
8	Stator	1
9	Rotor	1
10	Washer	1
11	Bearing	1
12	Motor Housing	1
13	Power Cord	1
14	Cable Guard	1
15	Brush Cap	2
16	Brush Holder	2
17	Spring	2
18	Carbon Brush (installed)	2
18a	Carbon Brush (replacement)	2
19	Cable Clamp	1
20	Screw	2
21	Rear Housing	1
22	Screw	4
23	Power Switch	1
24	Guide	1
25	Nut	2

Part	Description	Qty
26	Spring	2
27	Wing Nut	2
28	Guide Pole	2
29	Pin	1
30	Lock Lever	1
31	Nut	1
32	Block	1
33	Bolt	1
34	Screw	4
35	Right Handle (a)	1
36	Spring	2
37	Wing Nut	2
38	Right Handle (b)	1
39	Flat Cap Screw	3
40	Base Slider	1
41	Screw	4
42	Left Handle (a)	1
43	Left Handle (b)	1
44	Clinch Bolt	3
45	Base	1
46	Scale Ring	1
47	1/4" Collet Chuck (not shown)	1
48	3/8" Collet Chuck (not shown)	1
50	Spindle Wrench (not shown)	1
51	Collet Nut Wrench (not shown)	1

Record Product's Serial Number Here: _____

Note: If product has no serial number, record month and year of purchase instead.

Note: Some parts are listed and shown for illustration purposes only, and are not available individually as replacement parts.

PLEASE READ THE FOLLOWING CAREFULLY

THE MANUFACTURER AND/OR DISTRIBUTOR HAS PROVIDED THE PARTS LIST AND ASSEMBLY DIAGRAM IN THIS MANUAL AS A REFERENCE TOOL ONLY. NEITHER THE MANUFACTURER OR DISTRIBUTOR MAKES ANY REPRESENTATION OR WARRANTY OF ANY KIND TO THE BUYER THAT HE OR SHE IS QUALIFIED TO MAKE ANY REPAIRS TO THE PRODUCT, OR THAT HE OR SHE IS QUALIFIED TO REPLACE ANY PARTS OF THE PRODUCT. IN FACT, THE MANUFACTURER AND/OR DISTRIBUTOR EXPRESSLY STATES THAT ALL REPAIRS AND PARTS REPLACEMENTS SHOULD BE UNDERTAKEN BY CERTIFIED AND LICENSED TECHNICIANS, AND NOT BY THE BUYER. THE BUYER ASSUMES ALL RISK AND LIABILITY ARISING OUT OF HIS OR HER REPAIRS TO THE ORIGINAL PRODUCT OR REPLACEMENT PARTS THERETO, OR ARISING OUT OF HIS OR HER INSTALLATION OF REPLACEMENT PARTS THERETO.

Assembly Diagram

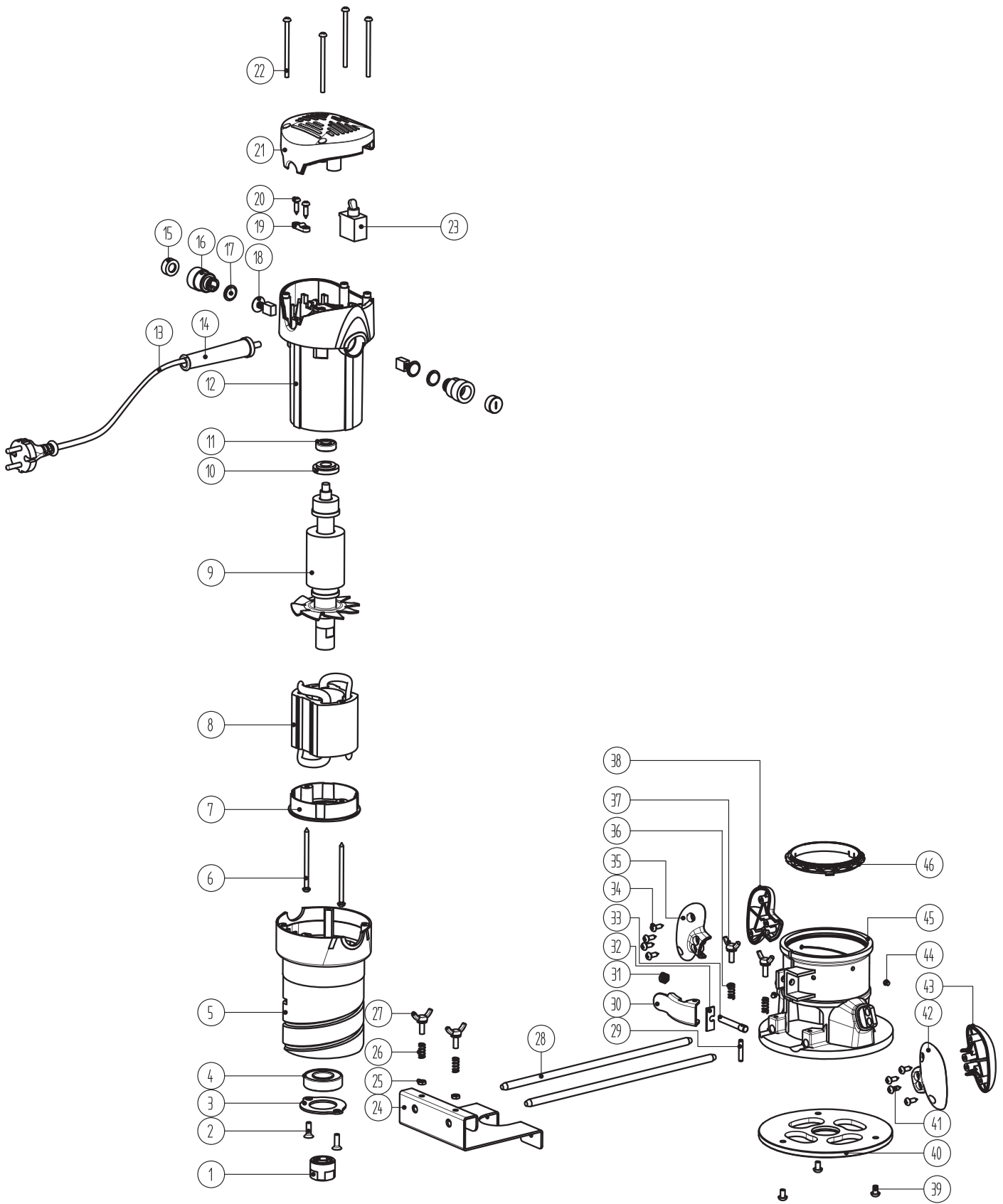

Limited 90 Day Warranty

Harbor Freight Tools Co. makes every effort to assure that its products meet high quality and durability standards, and warrants to the original purchaser that this product is free from defects in materials and workmanship for the period of 90 days from the date of purchase. This warranty does not apply to damage due directly or indirectly, to misuse, abuse, negligence or accidents, repairs or alterations outside our facilities, criminal activity, improper installation, normal wear and tear, or to lack of maintenance. We shall in no event be liable for death, injuries to persons or property, or for incidental, contingent, special or consequential damages arising from the use of our product. Some states do not allow the exclusion or limitation of incidental or consequential damages, so the above limitation of exclusion may not apply to you. THIS WARRANTY IS EXPRESSLY IN LIEU OF ALL OTHER WARRANTIES, EXPRESS OR IMPLIED, INCLUDING THE WARRANTIES OF MERCHANTABILITY AND FITNESS.

To take advantage of this warranty, the product or part must be returned to us with transportation charges prepaid. Proof of purchase date and an explanation of the complaint must accompany the merchandise. If our inspection verifies the defect, we will either repair or replace the product at our election or we may elect to refund the purchase price if we cannot readily and quickly provide you with a replacement. We will return repaired products at our expense, but if we determine there is no defect, or that the defect resulted from causes not within the scope of our warranty, then you must bear the cost of returning the product.

This warranty gives you specific legal rights and you may also have other rights which vary from state to state.

3491 Mission Oaks Blvd. • PO Box 6009 • Camarillo, CA 93011 • (800) 444-3353

drillmaster®

3491 Mission Oaks Blvd. • PO Box 6009 • Camarillo, CA 93011 • (800) 444-3353